

# Coolmay Multi-channel temperature control module CM-4TM

## User Manual

## Contents

<b><i>Introduction to use the manual.....</i></b>	<b><i>V</i></b>
<b><i>Descriptions of symbols in the communication manual.....</i></b>	<b><i>V</i></b>
<b><i>Safety Instructions.....</i></b>	<b><i>VI</i></b>
<b><i>Operation Precautions.....</i></b>	<b><i>VII</i></b>
<b><i>Chapter 1 Product Introduction.....</i></b>	<b><i>1</i></b>
<b><i>1.1 Characters.....</i></b>	<b><i>1</i></b>
<b><i>1.2 Components and accessories.....</i></b>	<b><i>2</i></b>
<b><i>1.3 Components and features.....</i></b>	<b><i>3</i></b>
1.3.1 Front.....	3
1.3.2 Bottom - wiring part.....	4
<b><i>Chapter 2 Product Specifications.....</i></b>	<b><i>5</i></b>
<b><i>2.1 Specification.....</i></b>	<b><i>5</i></b>
<b><i>Chapter 3 Wiring diagram and module connection diagram.....</i></b>	<b><i>7</i></b>
<b><i>3.1 Wiring diagram -front view.....</i></b>	<b><i>7</i></b>
<b><i>3.2 Wiring precautions.....</i></b>	<b><i>8</i></b>
3.2.1 Sensor connection.....	8
3.2.2 Power connection.....	9
3.2.3 Communication connection.....	9
<b><i>3.3 Preparation and start.....</i></b>	<b><i>9</i></b>
3.3.1 Overall sequence of operations.....	9
3.3.2 Set value status when power-on.....	9
<b><i>Chapter 4 Parameter settings and functions.....</i></b>	<b><i>28</i></b>
<b><i>4.1 Input.....</i></b>	<b><i>28</i></b>
4.1.1 Input type and temperature range.....	28
4.1.2 Input type setting.....	29
4.1.3 Input sensor temperature unit setting.....	29
4.1.4 Input deviation correction setting.....	30
4.1.5 Input digital filter setting.....	30
4.1.6 SV Upper/lower limit setting.....	31
<b><i>4.2 Control output.....</i></b>	<b><i>32</i></b>
4.2.1 Control output operation setting.....	32
4.2.2 MV Upper/lower limit setting.....	34
4.2.3 Slope setting.....	35
4.2.4 Automatic/manual control settings.....	36
<b><i>4.3 Temperature control.....</i></b>	<b><i>38</i></b>

4.3.1 Temperature control method setting.....	38
4.3.2 ON/OFF control.....	38
4.3.3 PID control.....	39
4.3.4 Self-tuning.....	41
<b>4.4 Communication.....</b>	<b>43</b>
4.4.1 Communication address setting.....	43
4.4.2 Communication speed setting.....	44
4.4.3 Communication Parity Bit Setting.....	45
4.4.4 Communication stop bit setting.....	45
4.4.5 Communication response waiting time setting.....	45
4.4.6 Enabling/Disabling Communication Write Settings.....	46
<b>4.5 Additional features.....</b>	<b>46</b>
4.5.1 Monitoring function.....	46
4.5.2 Run/Stop Settings.....	47
4.5.3 Multi-segment SV.....	47
4.5.4 Error Detection Function.....	48
4.5.5 Parameter initialization functions.....	49
<b>Chapter 5 Troubleshooting method.....</b>	<b>51</b>
5.1 error display.....	51
5.2 Communication troubleshooting method.....	51
5.3 Control troubleshooting methods.....	52
<b>Chapter 6 Modbus RTU protocol.....</b>	<b>53</b>
6.1 Read coil status (Func 01-01H).....	53
6.2 Read Input Status (Func 02-02H).....	54
6.3 Read hold memory (Func 03-03H).....	55
6.4 Read input memory (Func 04-04H) .....	57
6.5 Preset a single memory (Func 06-06H) .....	58
6.6 Preset multiple memories (Func 16-10H) .....	59
6.7 Exception response - error code.....	60
<b>Chapter 7 Modbus mapping table.....</b>	<b>62</b>
7.1 Read coil status / force single coil (Func: 01/05, RW:R/W) .....	62
7.2 Read input status (Func: 02, RW:R) .....	62
7.3 Read input memory (Func: 04, RW:R) .....	63
7.4 Read input memory (Func: 04, RW:R) .....	64
7.5 Read Hold Memory (Func 03) / Preset Single Memory ( Func 06) / Preset Multiple Memory ( Func 16).....	65
7.5.1 Monitoring function [ Func: 03/06/16, RW: R/W].....	65

7.5.2 Operation (control operation) function (Func: 03/06/16, RW: R/W).....	65
7.5.3 Master output function (Func: 03/06/16, RW: R/W).....	66
7.5.4 Initial setting function (Func: 03/06/16, RW: R/W).....	67
7.5.5 Set the master output function (Func: 03/06/16, RW: R/W).....	69
7.5.6 Setting options (communication settings) function (Func: 03/06/16, RW: R/W).	70





Thank you for purchasing Coolmay products.

This user manual includes the instructions and methods of the product. Please read it before using.

## Introduction to use the manual

- ◆ Please read carefully before using the product
- ◆ The purpose of this manual is to introduce the functions of this product in detail, and is not responsible for other purposes..
- ◆ This manual can not be edited or copied without authorization.
- ◆ This manual is not included with the product. Please download it from our website [www.coolmay.com](http://www.coolmay.com)
- ◆ The contents of this manual may differ due to product changes or other reasons without prior notice.
- ◆ Please leave us messages if you have any suggestions for this manual.



## Descriptions of symbols in the communication manual

Symbol	Description
 <b>Note</b>	Special function supplement.
 <b>Warning</b>	Warning sign, failure to follow this warning may result in accident or death
 <b>Caution</b>	Attention signs, failure to follow this warning may result in malfunction or product damage
 <b>Ex.</b>	Related function use examples
※1	comment mark

## Safety Instructions

Following these safety precautions ensures safe and correct use of the product and helps prevent accidents and reduce risk.

Safety instructions are divided into two categories: warning and caution:

 <b>Warning</b>	Warning sign, failure to follow this warning may result in accident or death
 <b>Caution</b>	Caution signs, failure to follow this warning may result in malfunction or product damage

### **Warning**

- ◆ When using large instruments (such as nuclear power, medical machinery, surveying, railway, aviation, combustion equipment, entertainment machinery, etc., including safety facilities) that have an impact on life or property, please make sure to perform double safety measures before using. Otherwise, fire, life-threatening, property damage may occur.

- ◆ Installed on the panel, otherwise it may cause electric shock.
- ◆ Make sure to disconnect the power supply while checking or repairing, otherwise it may cause electric shock.
- ◆ Please check the polarity of the power supply before powering up, otherwise it may cause fire.
- ◆ Please do not disassemble or modify the product. If you need internal inspection or repair, please contact our company. Otherwise, it may cause fire, electric shock and product damage.

### **Caution**

- ◆ Do not use this product outdoors, otherwise may result in short product life or electric shock.
- ◆ Use AWG 20 (0.5mm<sup>2</sup>) or better cable when connecting, otherwise it may cause fire.
- ◆ Use this product within the rated specifications, otherwise it may damage the

product or cause fire.

- ◆ Do not connect a load that exceeds the rated range, otherwise it may damage the product or cause fire.

- ◆ Do not use detergents such as water or oil to clean the product. Wipe it with a dry towel, otherwise may damage the product or cause fire.

- ◆ Do not use this product in a place that is flammable, explosive, humid, direct sunlight, high temperature, strong vibration or shock, otherwise it may cause fire or explosion hazard.

- ◆ Do not allow dust or wiring residue to go into the product, as this may cause fire or damage to the product.

- ◆ Please check if the polarity of the sensor is connected correctly before using, otherwise it may cause fire or explosion hazard.

## Operation Precautions

Please read the precautions carefully before using, otherwise it may cause damage to the product or accident.

### Power supply voltage and use environment

- ◆ Use the voltage within the rated range.
- ◆ Ambient temperature: -10°C ~ 50°C.
- ◆ Power on the product for 20 minutes before using.
- ◆ Install a switch or circuit breaker to control the power supply voltage of the product.
- ◆ Install the switch or circuit breaker near the product for easy operation.
- ◆ Please install and use this product in a well ventilated environment, if necessary, install a cooling fan.

- ◆ Please use the product in the environment as below.

Indoor, altitude below 2000m, pollution level 2, installation category II

## **Input sensor**

- ◆ If it is unavoidable to avoid the temperature detected by the sensor due to environmental factors, please use the deviation correction to minimize the error.

- ◆ When using a thermocouple sensor, please use the compensation wire of the rated range when extending the wire. Otherwise, the joint between the thermocouple and the extension wire will be thermally deformed, resulting in inaccurate measurement temperature.

- ◆ If using a RTD sensor, connect three terminals and use three cables with the same material, thickness and length. Otherwise, thermal deformation may occur, resulting in inaccurate measurement temperature.

- ◆ When changing the input sensor, please disconnect the power supply, connect the new sensor, and then power on the PC to modify the relevant parameters.

- ◆ Install the filter on the controller. In addition, install the shield wire near the power supply.

## **Noise impact**

- ◆ Product power line and high-voltage line are separately routed to prevent impulse noise interference.

- ◆ Please try to avoid high frequency noise interference in the environment, such as welding machine, sewing machine, high-capacity SCR controller and high-capacity motor.

- ◆ Do not use this product in accessories of high frequency broadcast, TV and wireless equipment.

## **Communication**

- ◆ Use twisted pair cable for communication cable and ferrule on both sides of the cable to reduce external noise interference.

- ◆ Do not arrange communication cables on the AC power accessories.

- ◆ Please use independent power supply voltage (24VDC) for communication converter.



# Chapter 1 Product Introduction

## 1.1 Characters

CM-4TM temperature controller module realized high-speed sampling (cycle: 100ms), side connection can expand up to 31 modules. It communicates with PC through RS485, and a variety of convenient and simple functions can achieve precise temperature control.

- ◆ Up to 124 simultaneous control
- ◆ Insulation strength per channel - dielectric strength 1,000VAC
- ◆ Up to 31 modules (124 channels / 62 channels) can be connected. The expansion modules used do not need additional communication and power supply.

- ◆ High-speed sampling period: 100ms
- ◆ Heating/cooling simultaneous control
- ◆ Sensor status can be monitored by current transformer (CT)
- ◆ Communicate with PC via RS485 (Modbus RTU)
- ◆ Connector wiring is convenient for wiring and maintenance: Sensor input interface, control output interface, power/communication connector use pluggable terminal

- ◆ Multi-channel inputs / multiple ranges
- ◆ Applications: Hot runner systems, electronic furnaces, reflow soldering, catapults and extruders

## 1.2 Components and accessories

### Components



Body



Terminals



**Note**

Please confirm whether the components are complete after your purchase. If any defects or damage, please contact the sales for after-sale services.

Please note that the power/communication connector is only included in the basic module.

Please visit the official website [www.coolmay.com](http://www.coolmay.com) to download the user manual.

## 1.3 Components and features

### 1.3.1 Front

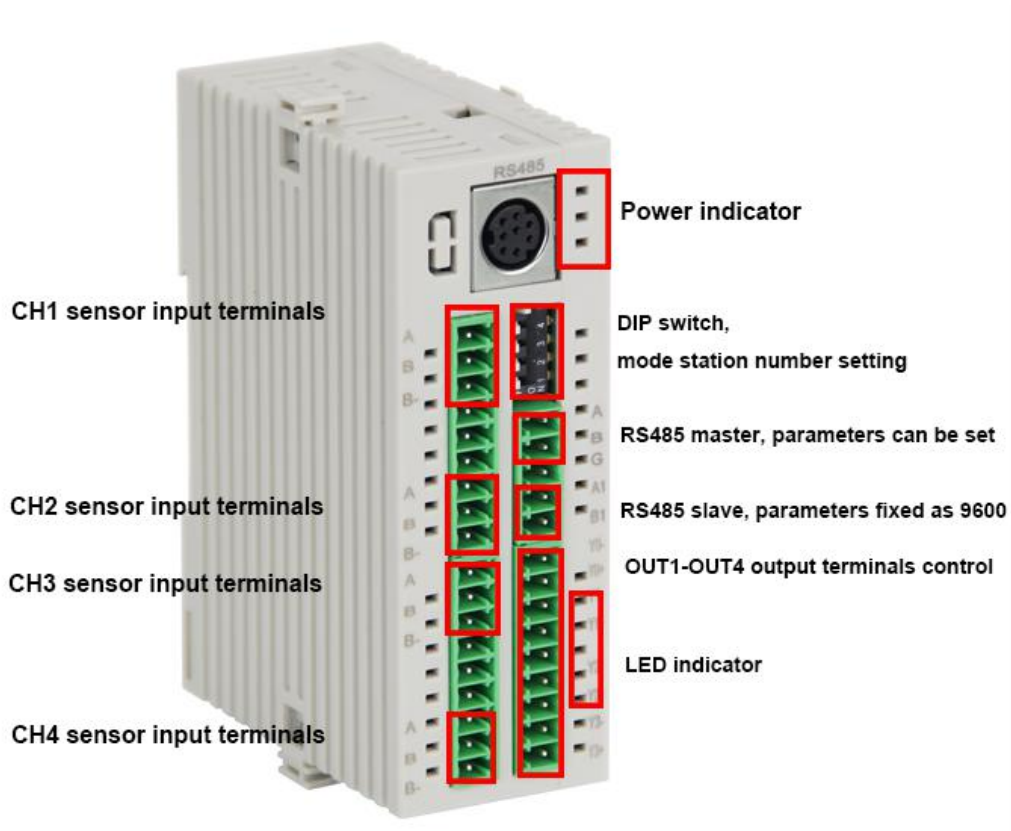

#### LED display

Status LED display	Power on ※1	Output control	Self tuning ※2
Power LED ※3	Green	Green	Green
CH1 LED	2400bps-flicker	ON-red	flicker
CH2 LED	4800bps-flicker	ON-red	flicker
CH3 LED	9600bps-flicker	ON-red	flicker
CH4 LED	19200bps-flicker	ON-red	flicker
	38400bps-flicker		

※1. After the power is on, the LED indicator will flash once in sequence, then locate the corresponding frequency with communication speed set earlier. The LED flashes for 5 seconds (cycle: 1 second).

\*2. The corresponding LED will flash while self tuning (cycle 1 second).

\*3: The power LED flickers while communicating with the outside (cycle 1 second).

**1.3.2 Bottom - wiring part**

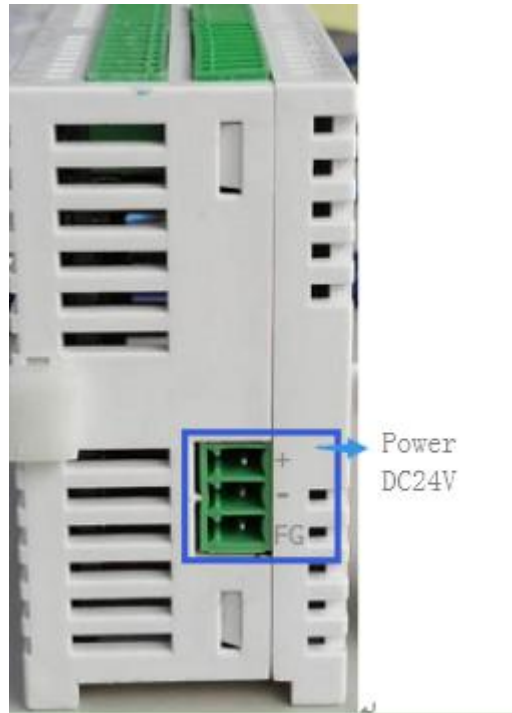

## Chapter 2 Product Specifications

### 2.1 Specification

Item		CM-4TM
Channels		4 channels----Each channel insulation, dielectric strength1,000VAC
Voltage		24VDC
Voltage range		Nominal voltage * 90% ~ 110%
Power		Max.5W (max load)
Display type		Non-display type - modify parameters and real-time monitoring (PC or PLC) via external device
Input	RTD	DPT100Ω, JPt100Ω 3 line(resistance: Max. 5Ω)
	Thermocouple	K, J, E, T, L, N, U, R, S, B, C, G and PLII (13 types)
Display precision	RTD	(PV±0.5% or ±1°C greater) < ±1 bit
	Thermocouple ※1	
Temperature effect ※2	RTD	(PV±0.5% or ±2°C greater) < ±1 bit, (If thermocouple input, ±5°C when lower than -100°C ), thermocouple L ,U, C, G, R, S, B: (PV±0.5% or ±5°C greater) < ±1bit
	Thermocouple	
Control output	Relay	250VAC 3 A 1a
	SSR	22VDC ±3V Max.30mA
Communication output		RS485 (Modbus RTU protocol)
Control mode	Heat, cool	ON/OFF control, P, PI, PD, PID control
	Heat & cool	
Lag		RTD/thermocouple: 1~100°C/°F (0.1~100.0°C/°F) optional
Proportional band (P)		0.1 ~ 999.9°C
Integral time (I)		0 ~ 9999 sec.
Derivative time (D)		0 ~ 9999 sec.
Control cycle		0.1~120.0 seconds (relay output, SSR drive voltage output type product)
Hand reset		0.0 ~ 100.0%
Sampling cycle		100ms(4 channels can be sampled simultaneously)
Proof voltage		1000VAC 50/60Hz last 1 minute (between input and power terminals)

Item	CM-4TM	
Vibration resistance	5 ~ 55Hz (1 minute cycle) amplitude 0.75mm X, Y, Z every direction 2 hours	
Relay life	Mechanical	> 10,000,000 times
	Electric	> 100,000 times (250VAC 3A resistive load)
Insulation resistance	> 100MΩ (based on 500VDC)	
Anti-interface	Interference simulator square wave interference (pulse width 1μs) ±0.5kV	
Environmental temperature	-10 ~ 50°C, Storage: -20 ~ 60°C	
Environmental humidity	35 ~ 85%RH, Storage: 35 ~ 85%RH	
Attachments	Expansion connector	
	Power/communication connector [Basic Module only]	
Insulation type	Double or reinforced insulation (dielectric strength between the input and power sections: 1kV)	
Certificate	CE, UL	
Weight	Approx. 135 ~ 152g	

\*1. Thermocouples K, T, N, J, E are below -100 °C and L, U, Platine II:  $\pm 2\text{ °C} \pm 1$  or less. When the thermocouple B is below 400 °C, the detection accuracy cannot be guaranteed. When R, S is below 200 °C, it is equal to C, G:  $3\text{ °C} \pm 1$  or less.

\*2. It is suitable for the situation beyond normal temperature ( $23\text{ °C} \pm 5\text{ °C}$ ).

Net weight of product refers to the table below.

Model	Weight
CM-4TM	Approx. 130g

## Chapter 3 Wiring diagram and module connection diagram

### 3.1 Wiring diagram -front view

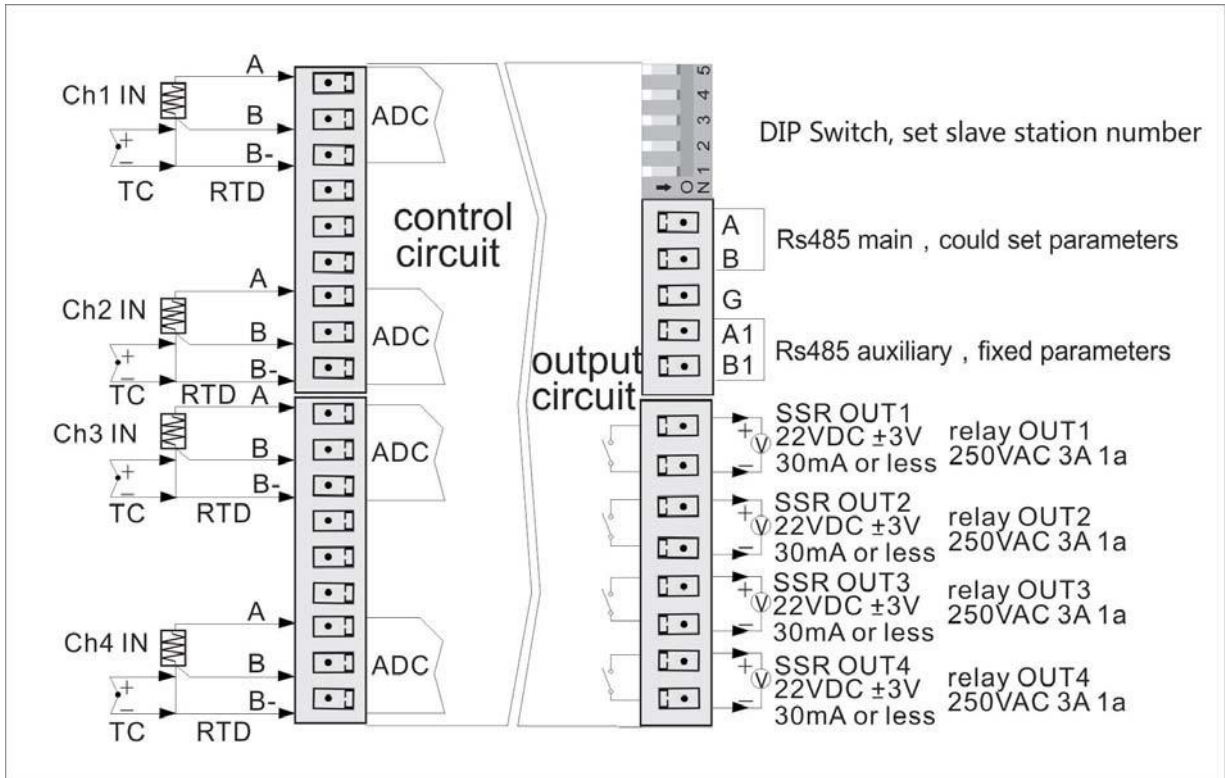

When wiring the thermocouple type, connect B, B-; When wiring the two-wire resistors, connect A and B; When wiring the three-wire resistor, connect A, B, B-.

 <b>Note</b>	Connecting the power/communication terminals, notice the polarity of the terminals.
	Use AWG 28-16 wires for sensors or compensation wires.
	When SSR output, recommend AWG 24 and above cables.
	When Relay output, recommend AWG 20 and above cables.

## 3.2 Wiring precautions

- ◆ Incorrect connection of the input terminal and output terminal may result in damage to the product.
- ◆ Please use the sensor type supported by this product.
- ◆ Make sure the SSR or load is within the rated range.
- ◆ Make sure the communication cable is properly connected to the communication terminals (A, B).
- ◆ Be sure to connect the polarity (+, -) of the terminal correctly.

### 3.2.1 Sensor connection

#### Compensation wire connection

When using a thermocouple sensor, if you extend the wire, use the same size compensation wire if you use different specifications.

The compensation wire may have a temperature error. Try to choose a high-performance compensation wire for more accurate temperature measurement.

#### Measurement error

- ◆ Do not connect the positive and negative polarity of the sensor.
- ◆ Please pay attention to maintain the distance between the load and the sensor.
- ◆ Make sure the sensor is securely connected to the terminal.

#### AC power wiring

Do not install the sensor near an AC power source.

#### Input sensor (or compensation wire) connection

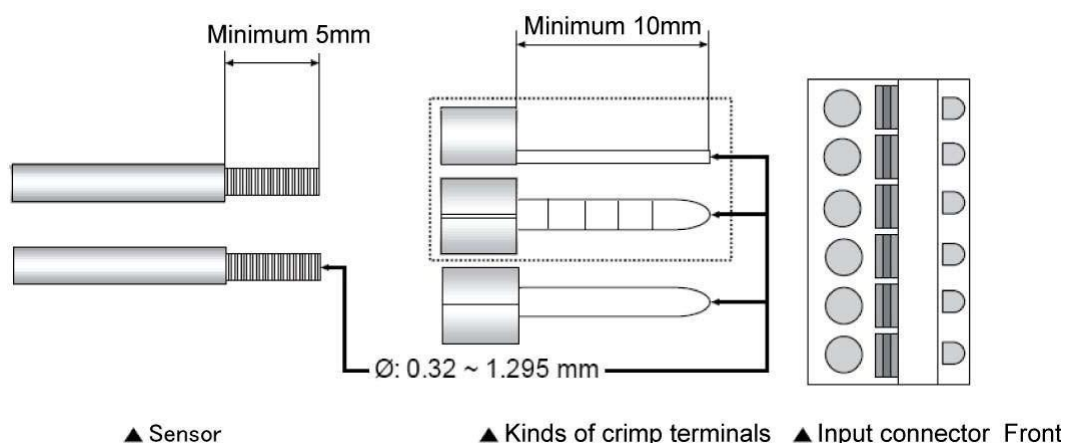



 <b>Note</b>	Make sure the sensor cable is fully inserted into the terminal.
	Sensor/crimp terminal connection spec AWG28~16 (DI: 0.32~1.295mm).
	Fix the sensor to make the measurement more accurate.

### 3.2.2 Power connection

Power supply wiring, please refer to **1.3.2 Bottom-power wiring**

 <b>Note</b>	Use AWG 24 ~ 12 specifications for the power cord.
	First calculate general power according to the usage and then connect the corresponding power.

### 3.2.3 Communication connection

For the communication connection, please refer to **1.3.1 introduction**.

## 3.3 Preparation and start

### 3.3.1 Overall sequence of operations

Perform the following steps before operating the CM -4TM for the first time.

1. All external devices, sensors and loads are connected to the CM -4TM terminals.
2. Modify the relevant parameters (PC, GP, etc.) through the external connection device.
3. Load the set parameters into the CM -4TM.
4. After setting the SV value, perform auto-tuning. Use this product after self-tuning. 品。

### 3.3.2 Set value status when power-on

Setting type	Factory default	Value before power-on	Value after power-on	Com address(CH1)※1
auto/ manual	auto	auto	auto	400004(0003H)
		manual	manual	
Run/stop	Run	Run	Run	400051(0032H)
		Stop	Stop	

PID/ONOFF	PID	PID	Keep presets	
		ONOFF	Keep presets	
MV	0.0	Preset MV	Keep presets	
	0.0	Stop MV	Keep presets	
	0.0	Sensor Error MV	Keep presets	

※1: The communication addresses involved in this manual are the addresses of channel 1 (CH1). For the address of channel 2-channel 4, please refer to Chapters 6 and 7..

## Chapter 4 Parameter settings and functions

### 4.1 Input

#### 4.1.1 Input type and temperature range

Input type		No.	Decimal	Parameter	Input range (°C)	Input range (°F)
Thermocouple	K(CA)	0	1	K(CA).H	-200 ~ 1350	-328 ~ 2462
		1	0.1	K(CA).L	-200.0 ~ 1350.0	-328.0 ~ 2462.0
	J(IC)	2	1	J(IC).H	-200 ~ 800	-328 ~ 1472
		3	0.1	J(IC).L	-200.0 ~ 800.0	-328.0 ~ 1472.0
	E(CR)	4	1	E(CR).H	-200 ~ 800	-328 ~ 1472
		5	0.1	E(CR).L	-200.0 ~ 800.0	-328.0 ~ 1472.0
	T(CC)	6	1	T(CC).H	-200 ~ 400	-328 ~ 752
		7	0.1	T(CC).L	-200.0 ~ 400.0	-328.0 ~ 752.0
	B(PR)	8	1	B(PR)	0 ~ 1800	32 ~ 3272
	R(PR)	9	1	R(PR)	0 ~ 1750	32 ~ 3182
	S(PR)	10	1	S(PR)	0 ~ 1750	32 ~ 3182
	N(NN)	11	1	N(NN)	-200 ~ 1300	-328 ~ 2372
	C(TT) ※1	12	1	C(TT)	0 ~ 2300	32 ~ 4172
	G(TT) ※2	13	1	G(TT)	0 ~ 2300	32 ~ 4172
	L(IC)	14	1	L(IC).H	-200 ~ 900	-328 ~ 1652
		15	0.1	L(IC).L	-200.0 ~ 900.0	-328.0 ~ 1652.0
	U(CC)	16	1	U(CC).H	-200 ~ 400	-328 ~ 752
		17	0.1	U(CC).L	-200.0 ~ 400.0	-328.0 ~ 752.0
Platinel II	18	1	PLII	0 ~ 1400	32 ~ 2552	
RTD	JPt100 Ω	19	1	JPt100.H	-200 ~ 600	-328 ~ 1112
		20	0.1	JPt100 .L	-200.0 ~ 600.0	-328.0 ~ 1112.0
	DPt100 Ω	21	1	DPt100.H	-200 ~ 600	-328 ~ 1112
		22	0.1	DPt100. L	-200.0 ~ 600.0	-328.0 ~ 1112.0

※1: C(TT): The same temperature sensor as W5 (TT).

※2: G(TT): The same temperature sensor as W(TT).

The sensor feeds the detected temperature back to the thermostat and then controls the temperature through the thermostat.

SV (set value) is only allowed to be set within the input range.

### 4.1.2 Input type setting

This product supports a variety of sensors, users can choose thermocouple or thermal resistance according to demand.

Different sensors can be used for each individual channel. Example): CH1 input type = KCA.H, CH2 input type = JIC.H

Parameter group	Parameter	Setting range	Factory default	Unit	Com address
Initial set function	CH1 Input type	Refer to 4.1.1	K(CA).H	-	400151(0096H)

 <b>Note</b>	<p>When input type is changed, the upper and lower input range will automatically change to the selected sensor input range, reset these parameters (SV, multi-segment SV setting, SV-0~SV-3 and input deviation correction are initialized) to ensure that the measurement environment remains unchanged.</p>
	<p>If the measured range is above or below the input range, HHHH (above), LLLL (lower) will be displayed, and OPEN will be displayed when the sensor is not connected or disconnected.</p>

### 4.1.3 Input sensor temperature unit setting

When the input sensor type is set, the temperature unit can be set according to the actual demand.

Parameter group	Parameter	Setting range	Factory default	Unit	Com address
Initial set function	CH1 Temp unit	°C/°F	°C	-	400152(0097H)

 <b>Note</b>	<p>When the temperature unit is changed, the input type remains the same, but SV, multi-segment SV setting, SV-0~SV-3, SV upper/lower limit and input deviation correction are initialized.</p>
---	---

### 4.1.4 Input deviation correction setting

This function is used to correct the deviation caused by the thermocouple and Thermal resistance sensor, rather than the deviation caused by the product.

The input deviation correction is mainly used when the sensor cannot be directly connected to the measurement target. This function can be used to correct the resulting temperature deviation.

Parameter group	Parameter	Setting range	Factory default	Unit	Com address
Initial set function	CH1 Input deviation	-999 ~ 999(H) -999.9 ~ 999.9(L)	0	bit	400153(0098H )

 <b>Ex.</b>	For example, the temperature is displayed at 78 ° C, but the actual temperature is 80 ° C. In this case, you can set the input deviation value to 2 and the display temperature to 80 ° C.
--	--

 <b>Note</b>	<ul style="list-style-type: none"> <li>• Make sure the actual temperature detected is correct, otherwise it will cause a larger error.</li> <li>• Most sensors have sensitivity grading, and higher sensitivity sensors are relatively expensive. Therefore, most sensors with medium sensitivity measure the sensitivity difference of each sensor and then set the input deviation value to ensure more accurate measurement temperature.</li> </ul>
---	--

### 4.1.5 Input digital filter setting

This feature allows the product to achieve high-precision temperature control. If the PV (display value) is not accurate due to noise components, interference, or input signal instability, the input digital filtering function can be used to achieve more precise temperature control.

Parameter group	Parameter	Setting range	Factory default	Unit	Communication address
Initial setting	CH1input digital	0.1~ 120.0	0.1	Sec	400154(0099H)

functions	filtering				
-----------	-----------	--	--	--	--

 <b>Ex.</b>	When the input digital filter is set to 0.4s, the input digital filter will take 0.4s (400ms) as the sampling period.
--	---

 <b>Note</b>	When using input digital filtering, the PV (display value) may differ from the actual measurement.
---	--

### 4.1.6 SV Upper/lower limit setting

The SV (set value) can be set to use the upper and lower limits to prevent product damage or accidents due to excessive or low set temperatures.

Parameter group	Parameter	Setting range	Factory default	Unit	Com address
Default setting function	SV Lower limit set	See the explanation below	-200	°C/°F	400155(009AH)
	SV Upper limit set		1350		400156(009BH)

\* SV lower limit: sensor lower limit range ~ SV upper limit value - 1 bit

\* SV upper limit: SV lower limit value + 1 bit ~ sensor upper limit range

 <b>Note</b>	If the upper/lower limits are set to exceed the sensor range, the set value will not be saved and the value before the setting will remain unchanged.
	SV (set value) is valid only in the upper and lower limits of SV.
	The SV lower limit does not exceed the SV upper limit.
	When the sensor input type is changed, it will be automatically changed to the sensor temperature range used. The user needs to reset the upper/lower limit values.

## 4.2 Control output

### 4.2.1 Control output operation setting

General temperature control includes heating, cooling or heating & cooling; heating control and cooling control are two opposite operations; the PID value will change as the control object changes.

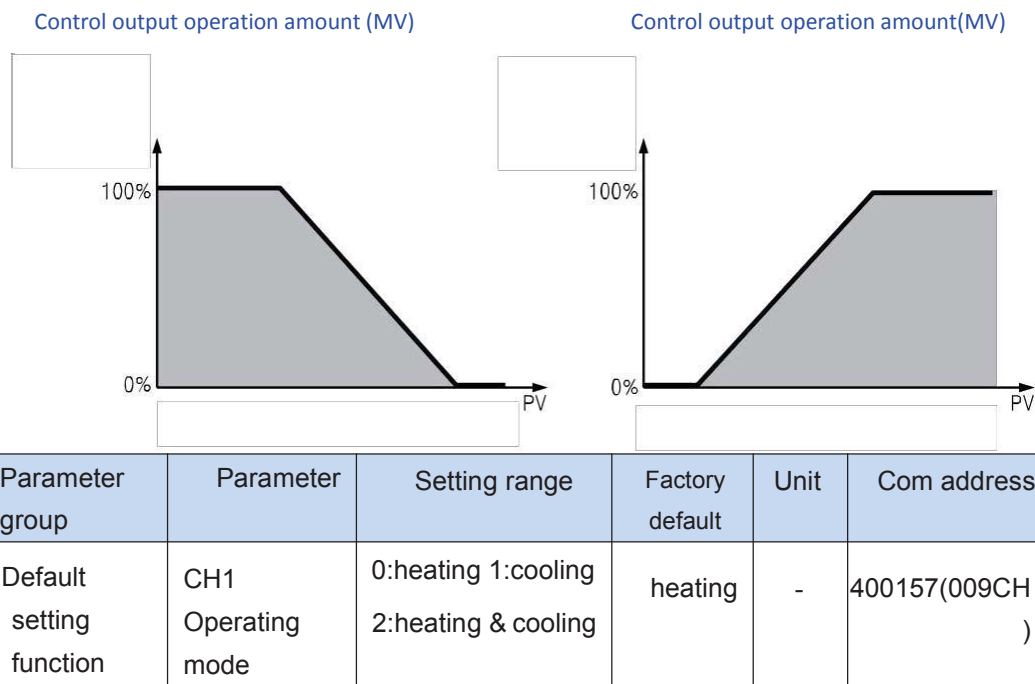

#### Heating control

Heating control mode: When PV (display value) is lower than SV (set value), the output control load (heater) operates.

#### Cooling control

Cooling control mode: When the PV (display value) is higher than SV (set value), the output control load (cooler) operates.

#### Heating & Cooling Control

Heating & Cooling Control: Heating & Cooling controls the same load action.

The heating & cooling mode can control the same object with different PID values, and can also set the same PID value control.

It is also possible to select the relay output, SSR output or current output depending

on the application (note that only the standard SSR can be used to control the SSR output in OUT2.

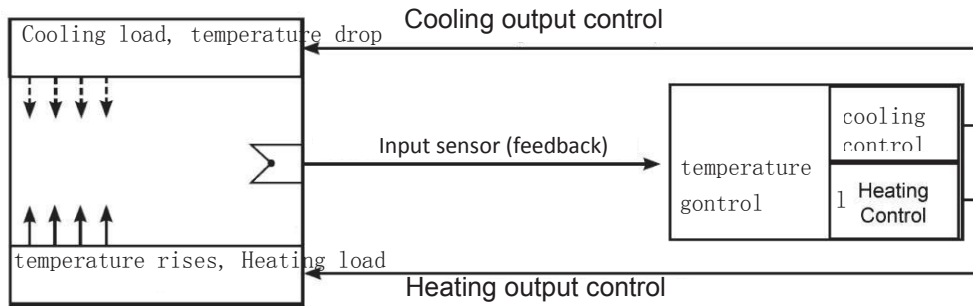

**Overlap/dead zone**

In heating and cooling control, the SV (setpoint) overlaps between the heating and cooling dead zones.

According to the SV value, DP is set to a positive value, and there is no control in the dead zone interval. Therefore, the control operation amount MV is 0 in the dead zone interval.

The overlap (heating and cooling simultaneous operation) zone is set to a negative value according

Parameter group	Associated parameter	Parameter	Setting range	Factory default	Unit	Communication address
Master output functions	PID-PID PID-ON/OFF ON/OFF-PID	CH1 dead zone	- proportional band ~ + proportional band	0.0	bit	400108(006BH)
	ON/OFF-ON/OFF		-999 ~ 0 ~ 999	0		

Set to 0 when no overlap/dead zone is used.

 <b>Note</b>	If the input is displayed in decimal, the display range is -999.9 ~ 999.9.
	When the proportional bands are different, the smaller one takes precedence.
	There is a decimal point when the sensor type (input.H, input.L) is set to input.L



### 4.2.2 MV Upper/lower limit setting

The setting of the MV upper/lower limit limits the amount of operation of the thermostat, which is beneficial to safety control.

For heating and cooling control, the cooling MV is prefixed with “-”, so the upper heating limit is controlled to + value and the lower cooling limit is controlled to - value.

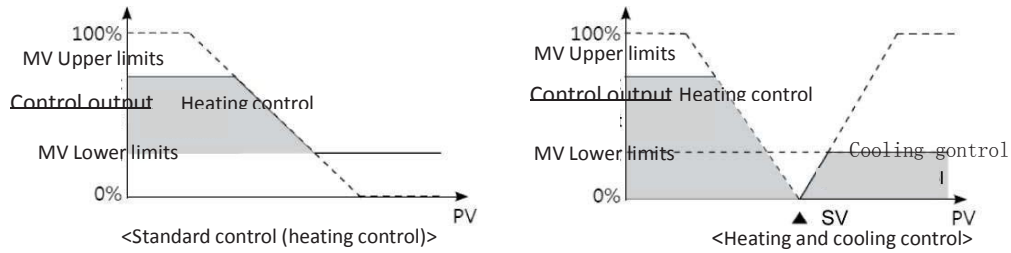

Parameter	Associated parameter	parameter	Setting range	Factory Default	Unit	Com address
Master output function	Cooling	CH1 MV Lower limits	0.0 ~ (MV Upper limits:-0.1)	0.0	%	400114(0071H)
		CH1 MV Upper limits	(MV Lower limits+ 0.1) ~ 100.0	100.0		400115(0072H)
	Heating&Cooling	CH1 MV Lower limits	-100.0 ~ 0.0	-100.0	%	400114(0071H)
		CH1 MV Upper limits	0.0 ~ 100.0	100.0		400115(0072H)

 <b>Note</b>	The amount of operation during the self-tuning process
	The amount of operation during manual control includes: the amount of operation when the control is stopped; the amount of operation when the sensor is faulty; and the initial amount of operation when the controller is manually controlled.
	The upper/lower limit of the MV does not apply to the ON/OFF mode in standard mode (heating or cooling).

## 4.2.3 Slope setting

The slope is a function related to SV (set value) that prevents the rate of SV from being limited due to a sudden change (increase or decrease) in the temperature of the controlled object.

Parameter group	Parameter	Setting range	Factory default	Unit	Communication address
Control operation	CH1 rising slope setting	0 (OFF) ~ 9999	0	-	400116(0073H)
	CH1 falling slope setting	0 (OFF) ~ 9999	0	-	400117(0074H)
	CH1 slope time unit	0: SEC (s) 1: MIN (m) 2: HOUR (h)	MIN	-	400118(0075H)

 <b>Ex.</b>	For ceramic or ceramic furnaces, heating too fast may damage the porcelain in the ceramic furnace, and the slope heating function can achieve slow heating.
--	---

 <b>Note</b>	When SV (set value) is operated based on the slope setting value based on PV (display value) and the value of SV or slope is changed, the SV operation amount changes according to the corresponding change amount.
	Determine the SV control object and set the corresponding slope according to the SV variation. (hereinafter referred to as RAMP SV)
	The amount of change in the rise and fall of the slope can be set separately.
	The alarm output and slope depend on the SV value.
	This function can't be used when the slope is set to 0.

### Slope state in different modes

Running Status	Slope	Slope function
All modes	=0	invalid
OPEN, HHHH, LLLL, Autotuning, Auto>Manual, RUN>STOP	Arbitrary value	invalid
OPEN, HHHH, LLLL, after Auto-tuning, PV = SV	Arbitrary value	invalid
Power on, SV change, control switch STOP switch to RUN, Control Switch Manual Switch to Auto, Slope or Slope Time Unit Change	≠0	invalid

### 4.2.4 Automatic/manual control settings

Automatic control: When PID control, the operation amount is automatically controlled according to the SV value. Manual control: In this mode, the user can freely set the operation amount according to the requirements.

Parameter Group	Parameter	Setting range	Factory Default	Unit	Com address
Monitoring function	CH1 automatic - manual control	0: automatic; 1: manual	Auto	-	400004(0003H)

The stop function can be set by setting the digital input terminals (DI1, DI2).

 <b>Note</b>	Auto/manual function can be switched freely by controlling the switch.
	Auto/manual control remains unchanged when the product is powered down or shut down.
	During operation, AT (auto-tuning) can be switched to manual control.
	In stop mode, manual control is activated.
	If SBA (sensor disconnection alarm) occurs during control, the sensor error operation amount will be used. In this state, it can be switched to manual control, and the manual control operation amount can also be modified.
	It is possible to switch to manual/automatic control during control operations.
	Priority: Manual Control > Stop > Disconnect (sensor disconnection).

#### Manual control of the amount of operation

When switching from automatic control to manual control, the initial operation amount can be set.

AUTO-MV: When switching from manual control to automatic control, the amount of operation is initialized.

PRESET-MV: Use the set operation amount as the initial value.

Parameter Group	Associated parameter	Parameter	Setting range	Factory default	Unit	Com address
Master control output function	PID	CH1 operation volume	0:Auto-MV: 1:Manual-MV	Auto-MV:	-	400202(00C9H)

※ When the power is turned back on after the power is turned off, the operation amount is controlled to output the value before the power is turned off.

### Initial operation amount during manual control

If the manual operation amount is set to PR.MV (manual preset MV), the initial MV can be manually modified.

Parameter Group	Associated parameter	Parameter	Setting range	Factory default	Unit	Com address
Master control output function	Heating, cooling, PID	CH1 Manual operation  Initial operation	0.0 ~ 100.0	0.0	%	400203(00CAH)
	Heating&cooling,PID		-100.0 (Cooling) ~ 0.0 ~ 100.0 (Heating)	0.0		

 <b>Note</b>	<p>0.1~ -100.0When heating and cooling control, the heating operation amount is set from 0.1 to 100.0, and the cooling operation amount is set from 0.1 to -100.0.</p>
---	--

## 4.3 Temperature control

### 4.3.1 Temperature control method setting

The temperature control method can be set by parameters.

Parameter Group	Associated parameter	Parameter	Setting range	Factory default	Unit	Com address
Initial setting function	heating, cooling	CH1 control way	0:PID:1:ON/OFF	0:PID	-	400158(009DH)
	heating&cooling		0:PID-PID 1:PID-ON/OFF 2:ON/ OFF-PID 3:ON/OFF- ON/OFF	0:PID-PID	-	

### 4.3.2 ON/OFF control

The ON or OFF state is controlled by comparing PV (display value) and SV (set value).

#### Hysteresis value setting

When the ON/OFF control output is used, the ON hysteresis and OFF deviation values can be set.

When the hysteresis value is set too low, it may cause frequent movements and cause interference (noise, vibration, etc.). In order to reduce interference, the appropriate ON and OFF offsets are set according to the heating and cooling capacity and thermal characteristics, the response frequency between the controller and the sensor, the installation environment and other relevant factors.

Parameter Group	Associated parameter		Parameter	Setting range	Factory Default	Com address
Master control output function	Heating	Heating	CH1 Heating hysteresis	1~100	2	400110(006DH)
			CH1 Heating deviation	0~100	0	400111(006EH)
	Cooling	Cooling	CH1 Cooling hysteresis	1~100	2	400112(006FH)
			CH1 Cooling deviation	0~100	0	400113(0070H)

### 4.3.3 PID control

PID is a combination of proportional band (P), integral (I), and differential (D). The control time is longer than ON/OFF, but the control accuracy is high.

Proportional band (P) control reduces oscillations; integral (I) controls correct for deviations; and differential (D) controls provide fast response to interference. Through the combined control of these three, precise temperature control can be achieved.

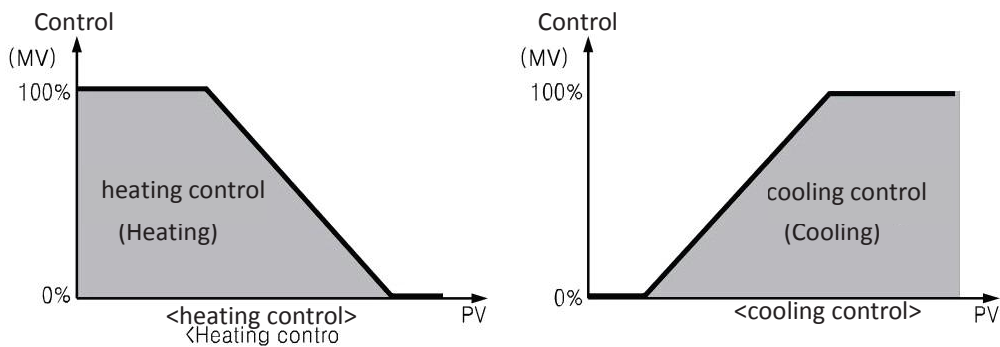

#### Note

PID control application

Proportional (P) control: When PID control is selected, the integration and derivative time are set to 0.

Proportional-Integral (PI) Control: When PID control is selected, the derivative time is set to 0.

Proportional-Derivative (PD) Control: When PID control is selected, the integration time is set to 0. When using the multi-segment SV function, the PID values of SV0 ~ SV3 are the same.

### Proportional band settings

When PV (display value) is within the proportional band (P) range, ON/OFF needs to adjust the proportional period (T), so the time period of proportional control is called the proportional band.

Parameter group	Associated parameter	Parameter	Setting range	Factory default	Unit	Com address
Master control output function	Heating, PID	CH1 Heating proportional band	0.1 ~	10	C	400102(0065H)
	Cooling, PID	CH1 Cooling proportional band	999.9			400103(0066H)

## Integration time setting

When there is a certain deviation, the time that the combined action and the proportional action work together is the integration time.

Parameter group	Associated parameter	Parameter	Setting range	Factory default	Unit	Com address
Master control output function	Heating, PID	CH1 Heating integration time	0 ~ 9999	0	Sec.	400104(0067H)
	Cooling, PID	CH1 Heating Integration time				400105(0068H)

 <b>Note</b>	<p>This function is not used if the integration time is set to 0. The integration time setting is too short. The correction action for interference is weak, but it is not easy to produce overshoot.</p>
---	---

## Derivative time setting

The time required for the differential action and the proportional control of the deviation on the slope is the differential time.

Parameter group	Associated parameter	Parameter	Setting range	Factory default	Unit	Com address
Master control output function	Heating, PID	CH1 Heating differential time	0 ~ 9999	0	Sec.	400106(0069H)
	Cooling, PID	CH1 Cooling differential time				400107(006AH)

 <b>Note</b>	<p>This function can't be used if the integration time is set to 0.</p>
---	---

## Control cycle setting

Under the control of the relay or SSR output, the output is kept for a fixed amount of time (the percentage of the manipulated variable during the control period) remains off. When the output ON/OFF changes to the proportional period control within the preset period. The SSR control output responds faster than the relay output, so the period required for control is shorter and easier to achieve sensitive temperature control.

Parameter group	Associated parameter	Parameter	Setting range	Factory default	Unit	Com address
Initial setting function	Heating, PID	CH1 Heating control cycle	0.1 ~ 120.0	20.0(Relay)	Sec.	400160(009FH)
	Cooling, PID	CH1 Cooling control cycle		2.0(SSR)		400161(00A0H)

	<b>Note</b>	If heating and cooling control is used, set the heating and cooling control cycles separately.
---	-------------	--

**Deviation correction / manual reset setting**

When only proportional control (P, PD control) is used, the heat capacity of the control object and the heat capacity of the heater affect the heating and cooling time. Therefore, there may be a certain deviation in the final control temperature, which can be corrected manually.

Parameter group	Associated parameter	Parameter	Setting range	Factory default	Unit	Com address
Master control output function	PID	CH1 Manual reset	0.0 ~ 100.0	50.0	%	400109(006CH)

**Manual reset adjustment based on control results**

Set the deviation to 50% for stable control

The deviation is 50% when PV=SV; the deviation exceeds 50% when PV<SV; the deviation is less than 50% when PV>SV.

	<b>Note</b>	The deviation function can only be used in proportional control. If the integration time is set to 0, the manual correction parameter value can be modified.
		Manual adjustment cannot be set during heating and cooling control, the parameter is automatically set to 0%
		Only applicable integration time is set to 0 (only in P or PD control)
		Automatically change to standard control (P, PD control) when switching heating and cooling control is 50%

**4.3.4 Self-tuning**

During PID control, the required PID value is automatically adjusted according to the thermal characteristics and response speed of the control object, so that the product can respond quickly and accurately control the temperature.

**Auto-tuning ON/OFF setting**

The PID value is automatically saved after the auto-tuning is completed, and the user can also set the PID value according to the usage environment.



During the self-tuning process, the LED output lamp flashes once every 1 second, and after the end, the LED output lamp goes out, and the auto-tuning state is automatically changed from ON to OFF.

Parameter group	Associated parameter	parameter	Predetermined area	Factory default	Unit	communication address
Master output function	PID	CH1 PID	0: OFF 1: ON	OFF	-	400101(0064H)

 <b>Note</b>	If you change to manual control during auto-tuning, auto-tuning will end automatically
	If a sensor error prompt occurs during auto-tuning, the auto-tuning ends and the PID value before tuning is maintained.
	Even if the temperature is higher or lower than the input range, the operation continues during the auto-tuning process.
	During the auto-tuning process, related parameters can only be viewed and cannot be modified.
	When auto-tuning is in progress, if the digital input (DI-1, DI-2) is run/stop or auto/manual, and the sensor has an error, the auto-tuning ends automatically.
	Auto-tuning is not available during manual control

### Self-tuning mode setting

Auto-tuning is based on the use of optional Tun1 mode (SV) or Tun2 mode (70% of SV).

Tun1 mode [TUN1]: Automatically adjusts the PID value based on SV.

Tun2 mode [TUN2]: Self-tuning PID value based on 70% of SV.

default setting	PID	CH1 PID type	0: Tun1 1: Tun2	Tun1	-	400159(009EH)
Features						

 <b>Note</b>	In cooling mode, Tun2 is based on 70% of 0°C. Example: If the SV is -100, the Tun2 execution benchmark is -70 °C.
---	--

## 4.4 Communication

Function for setting parameters and monitoring data after the controller is connected to an external device (PC, GP, etc.)

There is no duplicate address in the same communication line, and the communication cable must use twisted pair to support RS485 communication.

interface

Types	Description
Applicable standard	Meets EIA RS 485-standard
Maximum connection	31 (address: 01 ~ 31)
way of communication	2-wire half duplex
Communication synchronization	asynchronous(Asynchronous)
Communication effective distance	Max. 800m
BPS(Communication rate)	2400, 4800, 9600, 19200, 38400 bps
Communication response time	5 ms ~ 99 ms
Start bit	1 bit(fixed)
Data bit	8 bit(fixed)
Parity bit	None, odd, even
Stop bit	1, 2bit
protocol	Modbus RTU

### 4.4.1 Communication address setting

- ◆Each product can be set to a unique address
- ◆Set the communication address using the communication address setting switch
- ◆Setting range: 01 ~ 31
- ◆Factory default 01

<b>Dial switch</b>	<b>5</b>	<b>4</b>	<b>3</b>	<b>2</b>	<b>1</b>
--------------------	----------	----------	----------	----------	----------

OFF	0	0	0	0	0
ON	1	1	1	1	1

For example: In the example, dial 1, 2, 4, and 5 of the DIP switch to OFF, indicating that the module's communication address is 03H.

For example, dial 1 and 5 of the DIP switch to turn ON, 2, 3, and 4 to OFF, indicating that the module's communication address is 11H.



	<b>Note</b> When it is set to all OFF, that is, 0, communication will not be possible.
---	--

### 4.4.2 Communication speed setting

Can set the data transmission speed

Parameter group	parameter	Predetermined area	Factory default	Unit	commuication address
Setting Options (communication setting) function	Bit per second	0: 2400, 1: 4800, 2: 9600,3: 19200 4: 38400	9600	bps	400301(012CH)

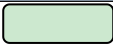
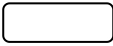
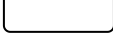
At power-on, the LED corresponding to the current set frequency flashes for 5 seconds (1 second period). For the specific LED lamp position, please refer to 1.3.1

LED	BPS (Bits/second)
	2400
	4800
	9600
	19200
	38400

	<b>Note</b> Communication ports A and B can be used for communication of multiple modules. After changing the communication speed, you need to power on again (power OFF → power ON)
---	--

	Communication ports A1, B1 are only suitable for single module communication, and the speed is fixed at 9600 bps.
	Make sure that the address of each module is unique. If there is an overlapping address, the modules with overlapping addresses will not communicate properly, and may even affect the normal communication of all products.

#### 4.4.3 Communication Parity Bit Setting

The check digit is an additional bit for each character in the transmitted data. It is used to verify the data loss and corruption. This parameter can be set to enable or disable the check digit option.

SV (Set value)	Description
0: NONE	Do not use parity bits
1: Even	Set an even parity bit
2: Odd	Set 1 odd parity bit

Parameter group	parameter	Predetermined area	Factory default	Unit	communication address
Setting Options (communication setting) function	Parity bit	0: NONE, 1: EVEN, 2: ODD	NONE	-	400302(012DH)

#### 4.4.4 Communication stop bit setting

Can set a stop character for transferring data

Parameter group	Parameter	Predetermined area	Factory default	Unit	communication address
Setting Options (communication setting) function	Stop bit	0: 1bit 1: 2bit	2	-	400303(012E)

#### 4.4.5 Communication response waiting time setting

When setting communication with (PC, PLC, etc.), in order to reduce communication errors, you can set the response waiting time and start working normally after the response time.

Parameter group	Parameter	Predetermined area	Factory default	Unit	communication address
Setting Options (communication setting) function	Communication response time	5~99	20	-	400304(012FH)

	<b>Note</b>	Setting the communication waiting time too short may cause communication errors.
---	-------------	--

#### 4.4.6 Enabling/Disabling Communication Write Settings

It is possible to set functions that are allowed or prohibited by communication with PC, GP, PLC, etc.

Parameter group	Parameter	Setting range	Factory default	Unit	communication address
Setting Options	Communication write	0: allow 1: forbid	allow	-	400305(0130H)

	<b>Note</b>	The communication write function does not affect the read parameters.
---	-------------	---

### 4.5 Additional features

#### 4.5.1 Monitoring function

##### Monitor control output operation

Monitor and display the current control output operation amount.

##### Monitor heating operation

- ◆ Monitor and display the current heating operation amount.
- ◆ The user can also control the temperature by manually adjusting the amount of operation.
- ◆ Measurement range: 0.0 ~ 100.0%.

##### Monitor refrigeration operations

- ◆ Monitor and display the current cooling operation.
- ◆ The user can also control the temperature by manually adjusting the amount of operation.
- ◆ Measurement range: 0.0 ~ 100.0%.

### 4.5.2 Run/Stop Settings

- ◆ In the operation mode, the control output can be forced to run or stop.
- ◆ The control output stops after the STOP command is sent.
- ◆ Control the run/stop function by setting the digital input terminals (DI-1, DI-2).

 <b>Note</b>	When the RUN/STOP function is set to the stop state, the STOP status remains valid even if the power is turned off again.
	Displays the current control output operation amount (Stop.MV) when the stop function is in effect, and keeps
	When power is restored after stopping, the initial operation amount is also the maximum operation amount.
	Re-powering after RUN/STOP setting is still valid

#### Control output stop

When the control output is stopped, select between 0.0 (OFF) and 100.0 (ON) under ON/OFF control.

Under PID control, the control output operation can be selected between 0.0 ~ 100.0.

Parameter group	Associated parameter		Parameter	Setting range	Factory default	Unit	Communication address
Master control Output Features	Heating, Cooling	PID	CH1 stop	0.0 ~ 100.0	0.0	%	400205(00CCH)
		ON/OFF		0.0(OFF) ~ 100.0(ON)			
	Heating & Cooling	PID	Operation volume	-100.0(Cooling) ~ 100.0(heating)	0.0		
		ON/OFF		-100.0(Cooling ON) / 0.0(OFF) / 100.0(heating ON)			

 <b>Note</b>	When set to STOP mode, ON/OFF control and PID control ignore the set operation amount
---	---

### 4.5.3 Multi-segment SV

The multi-segment SV function allows the user to set multiple SV values and save them to the SV0 ~ SV3 parameters. The desired SV value can be selected via the external digital input (DI-1, DI-2) terminals.

Supports up to 4 SV values, which can be set individually.

#### Number of multi-segment SVs

The multi-segment SV value can be set according to the number of control objects.

SV amount	SV parameters
0: 1EA	SV-0
1: 2EA	SV-0, SV-1
2: 4EA	SV-0, SV-1, SV-2, SV-3

### Multi-segment SV selection

Select the SV value according to your needs.

	<b>Note</b>	Select the SV value according to the actual use
---	-------------	---

### Multi-segment SV operation

Set the amount of operation corresponding to each SV value

Parameter group	Associated parameter	Parameter	Setting range	Factory default	Unit	Communication address
Master control Output Features	-	CH1 Multi channel SV	0: 1EA; 1: 2EA; 2: 4EA;	0	-	400201(00C8H)
operating (control operation) Features	Multi-channel SV	CH1Mu lti-chan -nel SV	0: SV-0 1: SV-1 2: SV-0 3: SV-1	SV-0	-	400052(0033H)
operating (control operation) Features	Multi-channel SV	CH1 SV-0 setting value	SV Lower limit ~ SV Upper limit	0	°C, °F	400053(0034H)
	Multi-channel SV	CH1 SV-1 setting value	SV Lower limit ~ SV Upper limit	0	°C, °F	400054(0035H)
	Multi-channel SV	CH1 SV-2 setting value	SV Lower limit ~ SV Upper limit	0	°C, °F	400055(0036H)
	Multi-channel SV	CH1 SV-3 setting value	SV Lower limit ~ SV Upper limit	0	°C, °F	400056(0037H)

## 4.5.4 Error Detection Function

When the thermostat detects an input signal error, it sends and displays this information.

The following conditions may cause an error condition, and when an error occurs, the LED flashes in a 0.5 second cycle.

- ◆ Sensor input exceeds the upper temperature range;
- ◆ Sensor input is below the lower temperature range;
- ◆ Sensor disconnected or not connected.

Once the error alarm is removed (sensor connected / restored to temperature range), the device will continue to operate normally

 <b>Note</b>	When power is turned on, or in the standard heating/cooling mode, HHHH is displayed when the control output is 0%, and LLLL is displayed when the control output is 100%.
	When power is turned on, or in the standard heating/cooling mode, the heating output is 0%, the HHHH is displayed when the cooling output is 100%, the heating output is 100%, and the LLLL is displayed when the cooling output is 0%.
	Manually control the output priority order: Heating (Cooling)_MV > Stop_MV > Sensor Error _MV
	Automatic control output priority: Stop _MV > Sensor Error _MV > Heating (Refrigeration) _MV

**Sensor error MV**

This function is used to control the sensor error during output, the user can set ON/OFF, MV setting, etc.

The MV value is controlled by ON/OFF or PID and is based on the MV control value.

**4.5.5 Parameter initialization functions**

This feature restores all parameters to their factory defaults.

Parameter groups	Parameter	Setting range	Factory default	Unit	Communicate address
Setting Options functions (communication setting)	Parameter initialization	1: YES 0: NO	NO	-	400306(0131H)



**Note**

If Yes is selected in the parameter, all parameters will be restored to factory defaults.

However, the communication parameters are not initialized.

## Chapter 5 Troubleshooting method

### 5.1 error display

The display LED flashes in a 0.5 second bit period, or the external communication connection device displays an error message.

OPEN indicates that the sensor is disconnected or not connected:

Power off check the sensor connection status. If the sensor is not broken, short the + and - poles with a wire and select the thermocouple sensor to see if the temperature controller displays room temperature. If the room temperature is not displayed, the thermostat may be damaged. Please contact our technical support department.

Make sure the sensor is connected correctly and select the corresponding input type

CM-4TM	LED condition	
	When disconnecting sensor input	When the temperature range is exceeded
PWR LED	Red light on	
CH1 LED	Red light flashes(0.5 second period)	
CH2 LED	Red light flashes(0.5 second period)	
CH3 LED	Red light flashes(0.5 second period)	
CH4 LED	Red light flashes(0.5 second period)	
Communication output (decimal number)	Communication output'31000'	Communication output'30000'(upper limit) Communication output'-30000'(lower limit)
For PC only	display'OPEN'	display'HHHH (upper limit)' display'LLLL (lower limit)'

### 5.2 Communication troubleshooting method

When using this product to connect to a communication external device without response or abnormal data:

- Make sure that the communication converter is normal.
- Do not route the AC power cord with the communication cable.
- Please supply power separately for the converter and the product.
- If the product is damaged due to internal circuits or strong interference, please contact our technical support department. In addition, the external interference of the product should be shielded as much as possible, and the internal circuit of the product may be

damaged due to continuous interference signals.

When the product is not properly connected to the external device:

- Check that the converter is properly powered.
- Check that the communication settings are correct.
- Check that the product is properly connected to the external device.

### **5.3 Control troubleshooting methods**

The control output does not work when using the product:

- Check that the product front panel output LEDs are working properly.
- If the output LED does not work, check each parameter. If the output LED is working properly, check that the controller output terminals (relay, SSR) are properly connected.

## Chapter 6 Modbus RTU protocol

### 6.1 Read coil status (Func 01-01H)

Read the output of the slave device (refer to OX state) ON/OFF state

#### 1. Inquiry (master side)

Slave address	function	initial address		Number of data		Error check(CRC16)	
		High	Low	High	Low	Low	High
1Byte	1Byte	1Byte	1Byte	1Byte	1Byte	1Byte	1Byte

← CRC16 →

#### 2. Answer (salve side)

Salve address	function	Number of bytes	data	data	data	Error check(CRC16)	
						Low	High
1Byte	1Byte	1Byte	1Byte	1Byte	1Byte	1Byte	1Byte

← CRC16 →

#### For example:

When the master side reads the output status of 10 coils 000001 (0000H) to 000010 (0009H) from the slave side (address 17) (ON: 1, OFF: 0).

#### Inquiry(master side)

Salve address	function	initial address		Numbers of data		Error check(CRC16)	
		High	Low	High	Low	Low	High
11 H	01 H	00 H	00 H	00 H	0A H	** H	** H

If the value of the slave side coil 000008 (0007H)~000001 (0000H) is "ON-ON-OFF-OFF-ON-ON-OFF-ON",The value of 000010(0009H)~000009(0008H) is "OFF-ON".

answer(slave side)

Slave address	function	Number of bytes	Data (000008-00000)	Data (000010-00000)	Error check(CRC16)	
			1)	9)	Low	High
11 H	01 H	02 H	CD H	01 H	**H	**H

## 6.2 Read Input Status (Func 02-02H)

Read the input of the slave device (refer to 1X state) ON/OFF state

Inquiry(master side)

Slave address	function	initial address		Numbers of data		Error check(CRC16)	
		High	Low	High	Low	Low	High
1Byte	1Byte	1Byte	1Byte	1Byte	1Byte	1Byte	1Byte

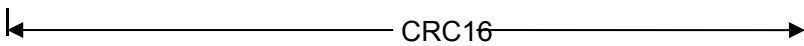

2 answer(slave side)

Slave address	function	Number of bytes	Data	Data	Data	Error check(CRC16)	
			1Byte	1Byte	1Byte	Low	High
1Byte	1Byte	1Byte	1Byte	1Byte	1Byte	1Byte	1Byte

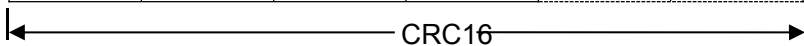

The master side reads the output state of the ten coils 10001 (0000H) to 100010 (0009H) from the slave side (address 17) (ON: 1, OFF: 0).

Inquiry (master side)

Slave address	function	initial address		Numbers of data		Error check(CRC16)	
		High	Low	High	Low	Low	High
11 H	02 H	00 H	00 H	00 H	0A H	** H	** H

If the value of the slave side coil 10008 (0007H) ~10001 (0000H) is "ON-ON-OFF-OFF-ON-ON-OFF-ON",

The value of 000010(0009H)~000009(0008H) is "OFF-ON".

answer(salve side)

Slave address	function	Number of bytes	data		Error check(CRC16)	
			(100008-100001)	(100010-100009)	Low	High
11 H	01 H	02 H	CD H	01 H	** H	** H

### 6.3 Read hold memory (Func 03-03H)

Read binary data from the device holding memory (refer to 4X state)

1. Inquiry (master side)

Slave address	function	initial address		Numbers of data		Error check(CRC16)	
		High	Low	High	Low	Low	High
1Byte	1Byte	1Byte	1Byte	1Byte	1Byte	1Byte	1Byte

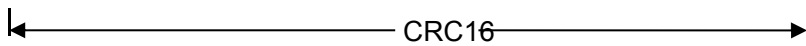

2. answer(salve side)

Slave address	Function	Number of bytes	data		data		data		Error check(CRC16)	
			High	Low	High	Low	High	Low	Low	High
1Byte	1Byte	1Byte	1Byte	1Byte	1Byte	1Byte	1Byte	1Byte	1Byte	1Byte

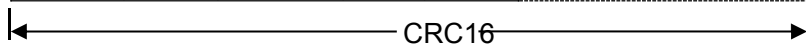

**Examples:**

The master side reads the values of the two holding memories 400001 (0000H) to 400002 (0001H) from the slave side (address 17).

Inquiry (master side)

Slave address	function	initial address		Numbers of data		Error check(CRC16)	
		High	Low	High	Low	Low	High
11 H	03 H	00 H	00 H	00 H	02 H	** H	** H

If the values from the side 400001 (0000H) ~ 400002 (0001H) are "555 (22B H)" and "100 (64 H)" respectively.

answer(salve side)

Slave address	function	Number of bytes	data		data		Error check(CRC16)	
			High	Low	High	Low	Low	High
11 H	03 H	04 H	02 H	2B H	00 H	64 H	** H	** H

## 6.4 Read input memory (Func 04-04H)

Read binary data from the input memory of slave device (refer to 3X state).

### 1. Inquiry (master side)

Slave address	Function	Initial address		Data quantity		Error check (CRC16)	
		High	Low	High	Low	Low	High
1Byte	1Byte	1Byte	1Byte	1Byte	1Byte	1Byte	1Byte

### 2. Answer(slave side)

Slave address	Function	Number of bytes	Data	Data	Data	Error check (CRC16)	
						Low	High
1Byte	1Byte	1Byte	1Byte	1Byte	1Byte	1Byte	1Byte

### For example:

The master side reads the values of the two input memories 300001 (0000H) to 300002 (0001H) from the slave side (address 17).

Inquiry (master side)

Slave address	Function	Initial address		Data quantity		Error check (CRC16)	
		High	Low	High	Low	Low	High
11 H	04 H	00 H	00 H	00 H	02 H	** H	** H

If the values of the slave side 300001 (0000H) ~ 300002 (0001H) are "10 (A H)" and "20 (14 H)", respectively.

Answer (slave side)

Slave address	Function	Number of	Data	Data	Error check(CRC16)
---------------	----------	-----------	------	------	--------------------



s		byte	High	Low	High	Low	Low	High
11 H	04 H	04 H	00 H	0A H	00 H	14 H	** H	** H

## 6.5 Preset a single memory (Func 06-06H)

Binary data written to a single memory (refer to the 4X state) from the slave device.

### 1. Inquire(master side)

Slave address	Function	Memory address		Preset data		Error check (CRC16)	
		High	Low	High	Low	Low	High
1Byte	1Byte	1Byte	1Byte	1Byte	1Byte	1Byte	1Byte

← CRC16 →

### 2. Answer(slave side)

Slave address	Function	Memory address		Preset data		Error check (CRC16)	
		High	Low	High	Low	Low	High
1Byte	1Byte	1Byte	1Byte	1Byte	1Byte	1Byte	1Byte

← CRC16 →

### For example:

The master side writes "10 (A H)" to the holding memory 400001 (0000H) of the slave side (address 17).

Inquiry (master side)

Slave address	Function	Initial address		Preset data		Error check (CRC16)	
		High	Low	High	Low	Low	High
11 H	06 H	00 H	00 H	00 H	0A H	** H	** H

Answer(slave side)

Slave address	Function	Initial address		Preset data		Error check (CRC16)	
		High	Low	High	Low	Low	High
11 H	06 H	00 H	00 H	00 H	0A H	** H	** H

## 6.6 Preset multiple memories (Func 16-10H)

The binary data of the holding memory (refer to the 4X state) is continuously written in the slave device.

### 1. Inquire (master side)

Slave address	Function	Initial address		Memory quantity		Number of byte	Data		Data		Error check (CRC16)	
		High	Low	High	Low		High	Low	High	Low	Low	High
1Byte	1Byte	1Byte	1Byte	1Byte	1Byte	1Byte	1Byte	1Byte	1Byte	1Byte	1Byte	1Byte

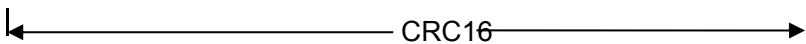

### 2. Answer(slave side)

Slave address	Function	Initial address		Memory quantity		Error check (CRC16)	
		High	Low	High	Low	Low	High
1Byte	1Byte	1Byte	1Byte	1Byte	1Byte	1Byte	1Byte

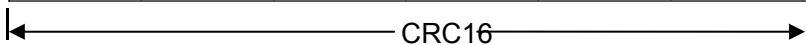

### For example:

The master side writes "10 (A H)" to the holding memory 400001 (0000H) ~ 400002 (0001H) of the slave side (address 17).

Inquiry (master side)

Slave address	Function	Initial address		Memory quantity		Number of byte	Data		Data		Error check (CRC16)	
		High	Low	High	Low		High	Low	High	Low	Low	High
11 H	10 H	00 H	00 H	00 H	02 H	04 H	00 H	0A H	00 H	0A H	** H	** H

Answer (slave side)

Slave address	Function	Initial address		Memory quantity		Error check (CRC16)	
		High	Low	High	Low	Low	High
11 H	10 H	00 H	00 H	00 H	02 H	** H	** H

When you use a slave device to connect to an external device such as a PLC or touch screen, use a single memory write function instead of using multiple memory write functions. However, in the PC loader, the minimum/maximum or base value of the parameter is preset by inputting the specification.

## 6.7 Exception response - error code

If an exception occurs, after the setting (1) accepts the highest level of the command (function), a response command is sent and each exception code is transmitted.

Slave address	Function +80H	Error code	Error check (CRC16)	
			Low	High
1Byte	1Byte	1Byte	1Byte	1Byte

- ◆Illegal operation function (error code: 01 H): Unsupported command
- ◆Illegal data address (error code: 02 H): The starting address of the query data is inconsistent with the address sent from the device.
- ◆Illegal data value (error code: 03 H): The number of query data is inconsistent with the

amount of data transmitted by the device

◆Slave device failure (error code: 04 H): The query command was not completed correctly

For example:

The master side reads the output state of the non-existing coil 001001 (03E8 H) (ON: 1, OFF: 0) from the slave side (address 17).

Inquire (master side)

Slave address	function	Initial address		Data quantity		Error check (CRC16)	
		High	Low	High	Low	Low	High
11 H	01 H	03 H	E8 H	00 H	01 H	** H	** H

Answer (slave side)

Slave address	Function +80H	Error code	Error check (CRC16)	
			Low	High
11 H	81 H	02 H	** H	** H

## Chapter 7 Modbus mapping table

### 7.1 Read coil status / force single coil (Func: 01/05, RW:R/W)

NO(address)	Parameter	Description	Predetermined area	Unit	Factory default
000001(0000)	CH1 Control output	CH1 Control output run/stop	0: RUN 1: STOP	-	RUN
000002(0001)	CH1 Auto-tuning	CH1 Auto-tuning run/stop	0: OFF 1: ON	-	OFF
000003(0002)	CH2 Control output	CH2 Control output run/stop	0: RUN 1: STOP	-	RUN
000004(0003)	CH2 Auto-tuning	CH2 Auto-tuning run/stop	0: OFF 1: ON	-	OFF
000005(0004)	CH3 Control output	CH3 Control output run/stop	0: RUN 1: STOP	-	RUN
000006(0005)	CH3 Auto-tuning	CH3 Auto-tuning run/stop	0: OFF 1: ON	-	OFF
000007(0006)	CH4 Control output	CH4 Control output run/stop	0: RUN 1: STOP	-	RUN
000008(0007)	CH4 Auto-tuning	CH4 Auto-tuning run/stop	0: OFF 1: ON	-	OFF
000009(0008)~ 000050(0031)	Reserved				

### 7.2 Read input status (Func: 02, RW:R)

NO(address)	Parameter	Description	Predetermined area	Unit	Factory default
100001(0000)	-	CH1 LED(output)	0: OFF 1:ON	-	
100002(0001)	-	CH2 LED(output)	0: OFF 1:ON	-	
100003(0002)	-	CH3 LED(output)	0: OFF 1:ON	-	
100004(0003)	-	CH4 LED(output)	0: OFF 1:ON	-	
100011(000A)~ 100050(0031)	Reserved				

### 7.3 Read input memory (Func: 04, RW:R)

NO(address)	Parameter	Description	Predetermination area	Unit	Factory default
300001(0000) ~300100(0063)	Reserved				
300101(0064)	-	Product number H	-	-	
300102(0065)	-	Product number L	-	-	
300103(0066)	-	Hardware version	-	-	
300104(0067)	-	Software version	-	-	
300105(0068)	-	Model name 1	-	-	"□□"
300106(0069)	-	Model name 2	-	-	"□□"
300107(006A)	-	Model name 3	-	-	"□□"
300108(006B)	-	Model name 4	-	-	"□□"
300109(006C)	-	Model name 5	-	-	" "
300110(006D)	-	Model name 6	-	-	" "
300111(006E)	-	Model name 7	-	-	" "
300112(006F)	-	Model name 8	-	-	" "
300113(0070)	-	Model name 9	-	-	" "
300114(0071)	-	Model name 10	-	-	" "
300115(0072)	-	Reserved	-	-	-
300116(0073)	-	Reserved	-	-	-
300117(0074)	-	Reserved	-	-	-
300118(0075)	-	Coil status start address	-	-	0000
300119(0076)	-	Coil state quantity	-	-	0
300120(0077)	-	Input status start address	-	-	0000
300121(0078)	-	Input state quantity	-	-	0
300122(0079)	-	Holding memory start address	-	-	0000
300123(007A)	-	Holding memory state quantity	-	-	0
300124(007B)	-	Input memory start address	-	-	0000
300125(007C)	-	Input memory state quantity	-	-	0
300126(007D)	-	Number of channels	-	-	0
300127(007E) ~300200(00C7)	Reserved				

## 7.4 Read input memory (Func: 04, RW:R)

NO(address)	Parameter	Description	Determination area	Unit	Factory default
301001(03E8)	CH1 Current value	Display measured value	Sensor type determines input range 31000: OPEN 30000: HHHH -30000: LLLL	°C/°F	-
301002(03E9)	CH1 Decimal point	Depending on the type of sensor selected	0: 0 1: 0.0	-	0
301003(03EA)	CH1unit	Temperature display unit	0: °C 1: °F	-	0
301004(03EB)	CH1 Set value	Set control temperature	SV Lower limit ~SV Upper limit	°C/°F	0
301005(03EC)	CH1 Heating_MV	Heating MV	0.0~100.0	%	-
301006(03ED)	CH1 Cooling_MV	Cooling MV	0.0~100.0	%	-
301007(03EE) ~301012(03F3)	CH2 parameter - same as above CH1				
301013(03F4) ~301018(03F9)	CH3 parameter - same as above CH1				
301019(03FA) ~301024(03FF)	CH4 parameter - same as above CH1				
301025(0400)		CH1 LED(output)	0: OFF 1: ON	-	-
	-	CH2 LED(output)	0: OFF 1: ON	-	-
	-	CH3 LED(output)	0: OFF 1: ON	-	-
	-	CH4 LED(output)	0: OFF 1: ON	-	-
	-	-	Fixed to 0	-	-
	-	-	Fixed to 0	-	-
	-	-	Fixed to 0	-	-
	-	-	Fixed to 0	-	-
	-	-	Fixed to 0	-	-
301026(0401)	Unit address	Unit address	01~31	-	01

301025(0400)address and data composition

Bit F	Bit E	Bit D	Bit C	Bit B	Bit A	Bit 9	Bit 8
-	-	-	-	-	-	DI-2 input	DI-1output
0	0	0	0	0	0	0 or 1	0 or 1

1Byte

Bit 7	Bit 6	Bit 5	Bit 4	Bit 3	Bit 2	Bit 1	Bit 0
AL4 LED	AL3 LED	AL2 LED	AL1 LED	CH4 LED	CH3 LED	CH2 LED	CH1 LED
0 or 1	0 or 1	0 or 1	0 or 1	0 or 1	0 or 1	0 or 1	0 or 1
1Byte							

## 7.5 Read Hold Memory (Func 03) / Preset Single Memory ( Func 06) / Preset Multiple Memory ( Func 16)

### 7.5.1 Monitoring function [ Func: 03/06/16, RW: R/W]

NO(address)	Parameter	Description	Determination area	Unit	Factory default
400001(0000)	CH1 SV	Set control temperature	SV Lowe limit ~SV Upper limit	°C/°F	0
400002(0001)	CH1 Heating_ MV	Heating MV	0.0~100.0	%	-
400003(0002)	CH1 Cooling_ MV	Cooling MV	0.0~100.0	%	-
400004(0003)	CH1 Auto- Manual control	Auto/Manual control	0: Auto 1:Manual	-	Auto
400005(0004) ~400050(0031)	CH1 Reserved				
401001(03E8) ~401050(0419)	CH2 parameter - same as above CH1				
402001(07D0) ~402050(0801)	CH3 parameter - same as above CH1				
403001(0BB8) ~403050(0BE9)	CH4 parameter - same as above CH1				

### 7.5.2 Operation (control operation) function (Func: 03/06/16, RW: R/W)

NO(address)	Parameter	Description	Determination areas	Unit	Factory default
400051(0032)	CH1 run--stop	Control output run/stop	0: RUN 1: STOP	-	RUN
400052(0033)	CH1 multi-segment	Multi-segment SV	0: SV-0 1: SV-1	-	SV-0



	SV code	code optional	2: SV-2 3: SV-3		
400053(0034)	CH1 SV-0 set value	SV-0 set value	SV Lower limit ~SV Upper limit	°C/°F	0
400054(0035)	CH1 SV-1 set value	SV-1 set value	SV Lower limit ~SV Upper limit	°C/°F	0
400055(0036)	CH1 SV-2 set value	SV-2 set value	SV Lower limit ~SV Upper limit	°C/°F	0
400056(0037)	CH1 SV-3 set value	SV-3 set value	SV Lower limit ~SV Upper limit	°C/°F	0
400057(0038) ~400100(0063)	CH1 Reserved				
401051(041A) ~401100(044B)	CH2 parameter - same as above CH1				
402051(0802) ~402100(0833)	CH3 parameter - same as above CH1				
403051(0BEA)~ 403100(0C1B)	CH4 parameter - same as above CH1				

### 7.5.3 Master output function (Func: 03/06/16, RW: R/W)

NO(address)	Parameter	Description	Determination area	Unit	Factory default
400101(0064)	CH1Auto-tuning	Auto-tuning execution/stop	0: OFF 1: ON	-	OFF
400102(0065)	CH1 Heating-proportional zone	Heating proportional zone	0.1~999.9	°C	10
400103(0066)	CH1 Cooling-proportional	Cooling proportional zone	0.1~999.9	°C	10
400104(0067)	CH1Heating-integration time	Heating integration time	0~9999	Second	0
400105(0068)	CH1Cooling -integration time	Cooling integration time	0~9999	Second	0
400106(0069)	CH1 Heating-derivative time	Heating derivative time	0~9999	Second	0
400107(006A)	CH1 Cooling-derivative	Cooling derivative time	0~9999	Second	0
400108(006B)	CH1 Dead zone	Dead zone that occurs in heating & cooling control mode	-P BAND~ +P BAND -999.9 ~ 999.9	Bit	0.0 0

400109(006C)	CH1 Manual reset	Manual reset in proportional control mode	0.0~100.0	%	50.0
400110(006D)	CH1 Heating hysteresis	Heating hysteresis	1~100(H) 0.1~100.0(L)	Bit	2
400111(006E)	CH1 Heating deviation	Heating deviation	0~100(H) 0.0~100.0(L)	Bit	0
400112(006F)	CH1 Cooling hysteresis value	Cooling hysteresis value	1~100(H) 0.1~100.0(L)	Bit	2
400113(0070)	CH1 Refrigeration deviation	Refrigeration deviation	0~100(H) 0.0~100.0(L)	Bit	0
400114(0071)	CH1 MV Lower limit	MV Lower limit set value	0.0 ~ MV upper limit-0.1 (normal control) -100.0 ~ 0 (Heating & Cooling Control)	%	0.0 -100
400115(0072)	CH1 MV Upper limit	MV Upper limit set value	MV Lower limit+ 0.1~100.0 0~100	%	100
400116(0073)	CH1 Rising slope	Rising slope set	0~9999	-	0
400117(0074)	CH1 Falling slope	Falling slope set	0~9999	-	0
400118(0075)	CH1 slope time	Slope time unit	0:second 1: minute 2: hour	-	minute
400119(0076) ~400150(0095)	CH1 Reserved				
401101(044C) ~401150(047D)	CH2 parameter - same as above CH1				
402101(0834) ~402150(0865)	CH3 parameter - same as above CH1				
403101(0C 1C) ~403150(0C4D)	CH4 parameter - same as above CH1				

### 7.5.4 Initial setting function (Func: 03/06/16, RW: R/W)

NO(address)	Parameter	Description	Determination area	Unit	Factory default
400151(0096)	CH1 input type	Input type	0: K(CA).H ~22: DPT100.L	-	K(CA).H
400152(0097)	CH1 unit	Temperature unit of the sensor	0: ℃ 1: ℉	-	℃

400153(0098)	CH1 Input deviation	Input deviation correction	-999~999	Bit	0
400154(0099)	CH1 Input digital filtering	Input digital filtering	0.1~120.0	Second	0.1
400155(009A)	CH1 SV Lower limit	SV Lower limit set value	Input lower limit range ~ SV upper limit - 1 bit	°C/°F	-200
400156(009B)	CH1 SV Upper limit	SV Upper limit set value	SV lower limit +1 bit ~Input upper limit range	°C/°F	1350
400157(009C)	CH1 Operating mode	Control output mode of operation	0: Heating 1: Cooling 2: Heating & Cooling	-	0
400158(009D)	CH1 Control mode	Control temperature mode	Standard control mode 0: PID 1: ONOFF	-	0
			Heating & Cooling control mode 0: PID-PID 1: PID-ONOFF 2: ONOFF-PID 3: ONOFF-ONOFF	-	0
400159(009E)	CH1 Auto-tuning type	Auto-tuning type	0: TUN1 1: TUN2	-	TUN1
400160(009F)	CH1 Heating control cycle	Heating control cycle	0.1~120.0	Sec.	20.0(RY) 2.0(SSR)
400161(00A0)	CH1 Cooling control cycle	Cooling control cycle	0.1~120.0	Sec.	20.0(RY) 2.0(SSR)
40162(00A1) ~400200(00C7)	CH1 Reserved				
401151(047E) ~ 401200(04AF)	CH2 parameter - same as above CH1				
402151(0866) ~ 402200(0897)	CH3 parameter - same as above CH1				
403151(0C4E) ~403200(0C7F)	CH4 parameter - same as above CH1				

**7.5.5 Set the master output function (Func: 03/06/16, RW: R/W)**

NO(address)	Parameter	Description	Determination area	Unit	Factory default
400201(00C8)	CH1 multi-segment SV	Multi-segment SV set	0: 1EA 1: 2EA 2: 4 EA	EA	0
400202(00C9)	CH1 Operation volume	Operation mode select	0:Auto – operation volume 1:Manual – operating volume	-	Auto - MV
400203(00CA)	CH1 When operating manually, Initial operation	When operating manually, Initial operation	0.0~100.0 (standard control mode) -100.0 ~ 100.0 (Heating & Cooling control mode)	%	0.0
400204(00CB)	CH1 Sensor error	The operation volume when the sensor is in error	1. standard control mode 1) PID control : 0.0 ~ 100.0 2)ON/OFF control : 0.0(OFF)/100.0(ON) 2. heating & cooling control 1) PID control : -100.0(cooling) ~ 100.0(heating) 2)ON/OFF control:-100.0(cooling ON) /0.0(OFF)/100.0(heating ON)	%	0.0
400205(00CC)	CH1 stop operation volume	When the control is stopped, the operation volume	1. standard control mode 1) PID control : 0.0 ~ 100.0 2)ON/OFF control : 0.0(OFF)/100.0(ON) 2. heating & cooling control 1) PID control: -100.0(cooling) ~ 100.0(heating) 2)ON/OFF control:-100.0(cooling ON) /0.0(OFF)/100.0(heating ON)	%	0.0
400206(00CD)	-	-	-	-	-
400207(00CE) ~400250(00F9)	CH1 Reserved				
401201(04B0) ~401250(04E1)	CH2 parameter - same as above CH1				
402201(0898) ~402250(08C9)	CH3 parameter - same as above CH1				

403201(0C80) ~403250(0CB1)	CH4 parameter - same as above CH1
-------------------------------	-----------------------------------

### 7.5.6 Setting options (communication settings) function (Func: 03/06/16,

RW: R/W)

NO(address)	Parameter	Description	Determination area	unit	Factory default
400301(012C)	Bit per second	Communication speed	0: 2400 1: 4800 2: 9600 3: 19200 4: 38400	-	9600
400302(012D)	Parity bit	Communication parity bit	0: None 1: Even 2: Odd	-	None
400303(012E)	Stop bit	Communication stop bit	0:1 1:2	-	2
400304(012F)	Response time	Communication response time	5~99	ms	20
400305(0130)	Communication write	Communication write permission/prohibition	0:permission 1:prohibition	-	permission
400306(0131)	Parameter initialization	Parameter initialization	0: NO 1: YES	-	NO
400307(0132) ~400350(015D)	Reserved				